

IHT12-N8APO50-A2T

Mind O≠0, I≠I≠1, S≠5, B≠8.

Housing size	M12×1
Mounting	non-flush
Sensing distance S_n	8 mm
Operating voltage	10...30 V _{DC}
Reverse polarity protection	built-in
Current consumption	<8 mA
Current load capability	120 mA
Output function	—/— normally open
Output polarity	PNP
Short circuit protection	built-in, self-resetting
Voltage drop	<2V @ 120 mA
Switching frequency	500 Hz
Reduction factors	Alu 0.45 · Brs 0.50 · VA 0.85
Operating temperature	−20...+120 °C · −3...+249 °F
Protection class	IP67
Sensing face material	PTFE
Housing material	SS 1.4301 (SAE 304)
Switching indicator	built-in*
Connection	PTFE
Clearance z	14 mm
Clearance x	14 mm
Complies with	CE, RoHS



25 months **Warranty** Our products are manufactured to stringent ISO 9001 European standards to ensure that our customers only receive the best quality.

Inductive Proximity Switch 3-Wire DC High Temperature Resistant Sensing range: *Increased*

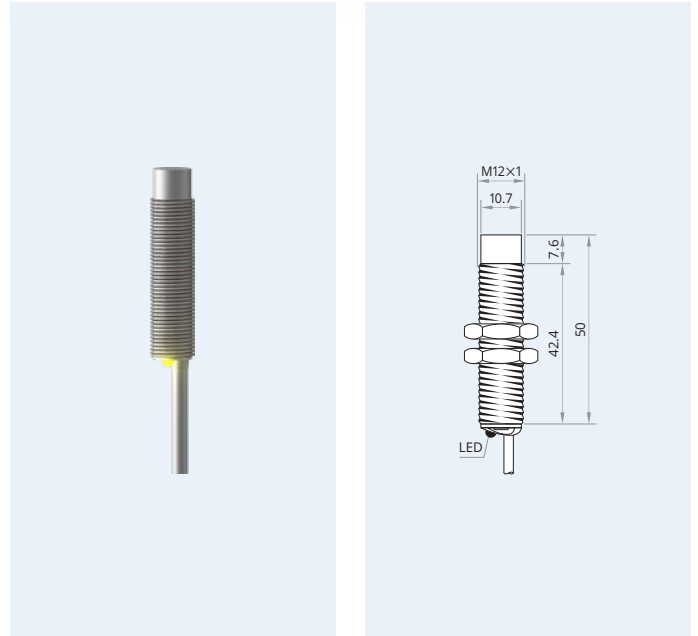

Maximum temperature: 120 °C · 249 °F

* Only for set-up. The LED may die if operated beyond 120 °C (249 °F). The LED is not covered by warranty.

Wiring diagram

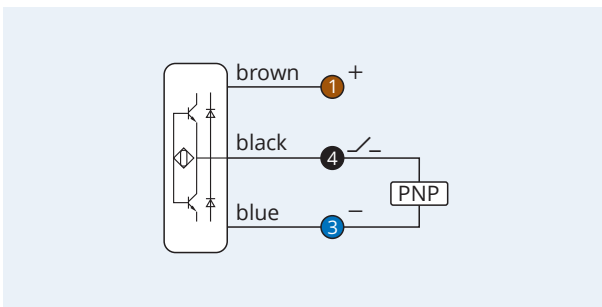

Clearance for parallel mounting

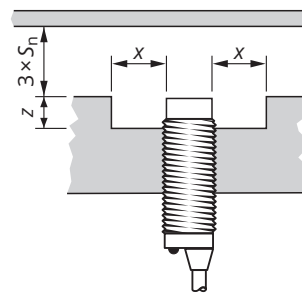

⚠ Caution! This device shall not be used if the safety of persons rely on its faultless function.

XECRO reserves the right to make minor changes without prior notification.