

IHT8-S2APC45-N2S

Mind O≠0, I≠I≠1, S≠5, B≠8.

Housing size	M8×1
Mounting	flush
Sensing distance S_n	2 mm
Operating voltage	10...30 V _{DC}
Reverse polarity protection	built-in
Current consumption	<8 mA
Current load capability	120 mA
Output function	┘ normally closed
Output polarity	PNP
Short circuit protection	built-in, self-resetting
Voltage drop	<2V @ 120 mA
Switching frequency	800 Hz
Reduction factors	Alu 0.45 · Brs 0.50 · VA 0.85
Operating temperature	-20...+120 °C · -3...+249 °F
Protection class	IP67
Sensing face material	PTFE
Housing material	SS 1.4301 (SAE 304)
Connection	silicone
Complies with	CE, RoHS



Inductive Proximity Switch 3-Wire DC High Temperature Resistant Sensing range: *Increased*

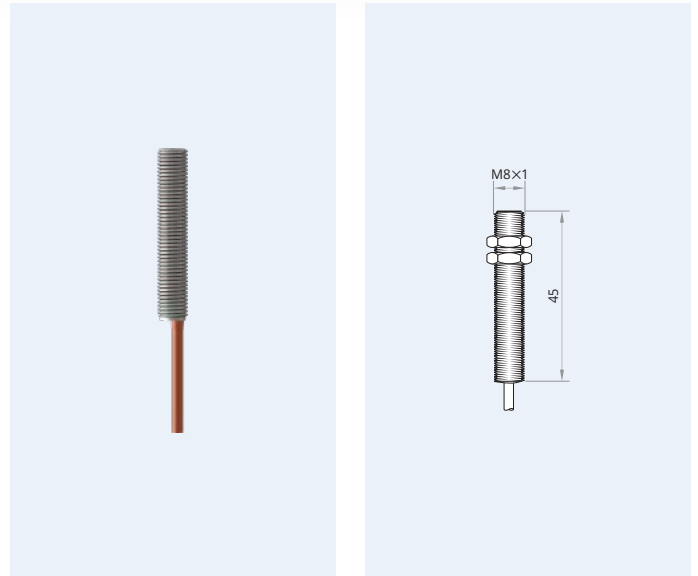

Maximum temperature: 120 °C · 249 °F



Warranty Our products are manufactured to stringent ISO 9001 European standards to ensure that our customers only receive the best quality.



Wiring diagram

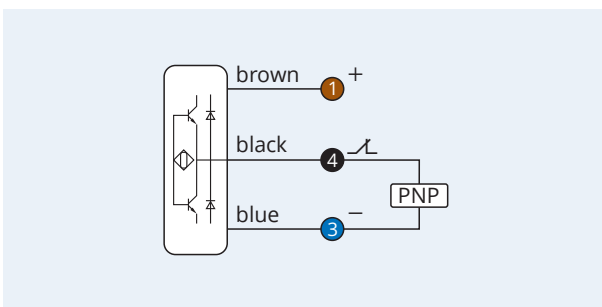

Clearance for parallel mounting

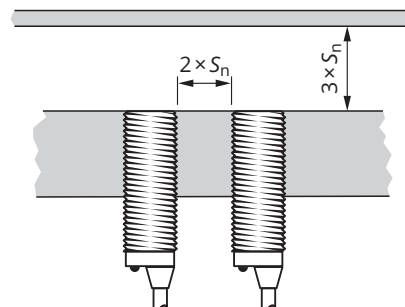

Clearance for opposing mounting



Caution! This device shall not be used if the safety of persons rely on its faultless function.

XECRO reserves the right to make minor changes without prior notification.