

IMF30-S10NO79-A12

Mind O≠0, I≠I≠1, S≠5, B≠8.

Housing size	M30×1.5
Mounting	flush
Sensing distance S_n	10 mm
Operating voltage	10...30 V _{DC}
Reverse polarity protection	built-in
Current consumption	<8 mA
Current load capability	200 mA
Output function	—/— normally open
Output polarity	NPN
Short circuit protection	built-in, self-resetting
Voltage drop	<1.5 V @ 200 mA
Switching frequency	200 Hz
Reduction factors	Alu 0.45 · Brs 0.50 · SS 0.85
Operating temperature	−20...+70 °C · −3...+159 °F
Protection class	IP69k, IP67 rear end
Sensing face material	SS 1.4301 (SAE 304)
Housing material	SS 1.4301 (SAE 304)
Switching indicator	built-in
Connection	male connector M12
Complies with	CE, RoHS



Inductive Proximity Switch 3-Wire DC Metal Face Sensing range: *Increased*

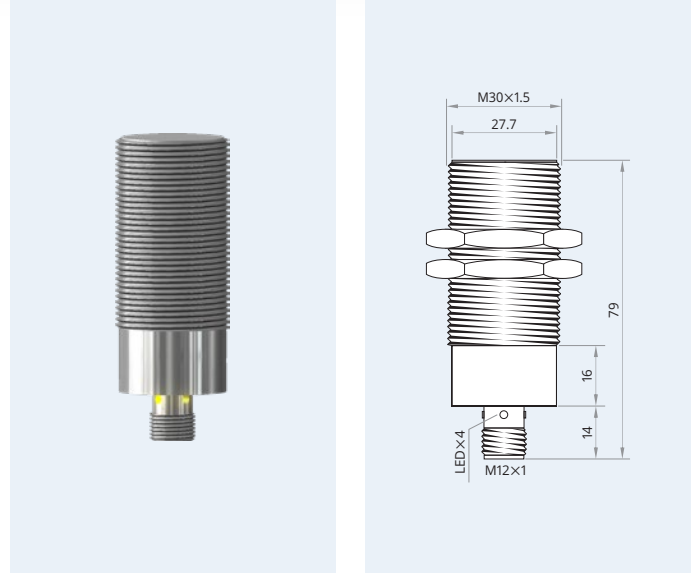

25 months **Warranty** Our products are manufactured to stringent ISO 9001 European standards to ensure that our customers only receive the best quality.

Wiring diagram

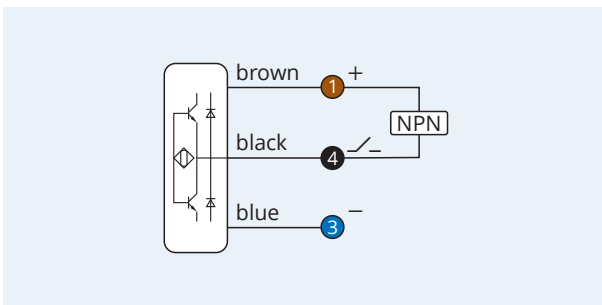

Pinout

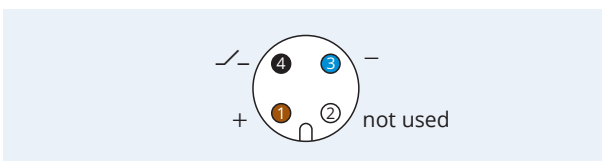

⚠ Caution! This device shall not be used if the safety of persons rely on its faultless function.

Clearance for parallel mounting

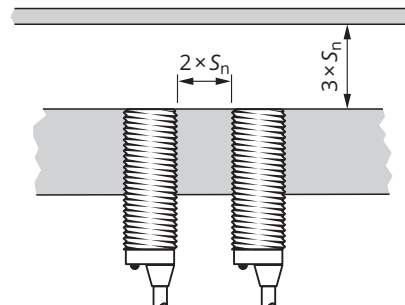

Clearance for opposing mounting



XECRO reserves the right to make minor changes without prior notification.