

IA12-S6VI020-G2P

Mind O≠0, I≠I≠1, S≠5, B≠8.

Housing size	M12×1
Mounting	semi-flush
Measuring range	0...6 mm
Operating voltage	15...30 V _{DC}
Reverse polarity protection	built-in
Current consumption	<25 mA
Load resistor*	V: ≥10 kΩ · I: ≤500 Ω
Output characteristics	0...10 V · 0...20 mA
Overload protection	built-in
Output frequency	≤300 Hz
Reduction factors	Alu 0.45 · Brs 0.50 · SS 0.85
Operating temperature	0...+70 °C · +33...+159 °F
IP code	IP67
Sensing face material	PBT
Housing material	brass
Connection	PVC, ultra-flex
Clearance z	2 mm
Complies with	CE, RoHS



Inductive Proximity Switch 4-Wire Analog Output Sensing range: *Extended*

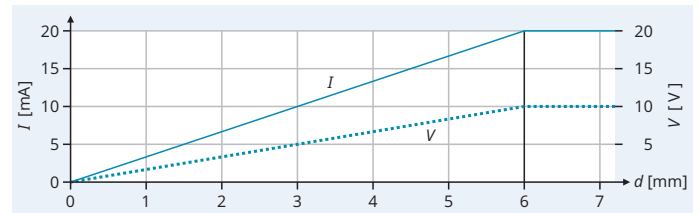
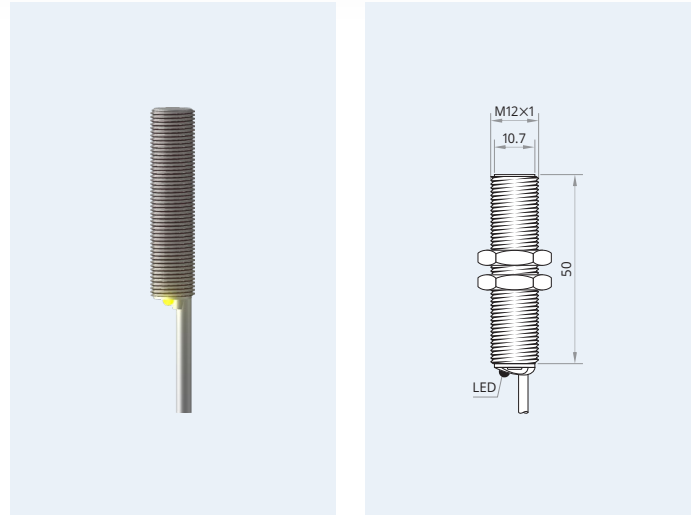

* V: for voltage output · I: for current output



Wiring diagram

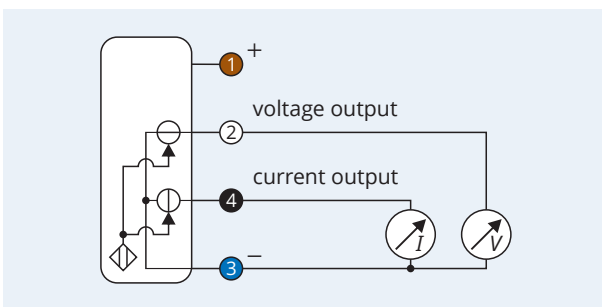

Clearance for parallel mounting

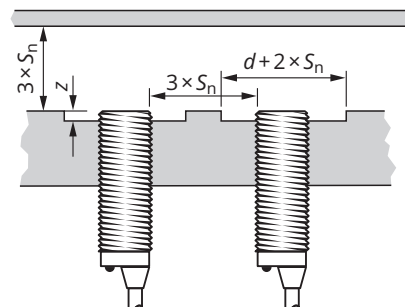

Clearance for opposing mounting

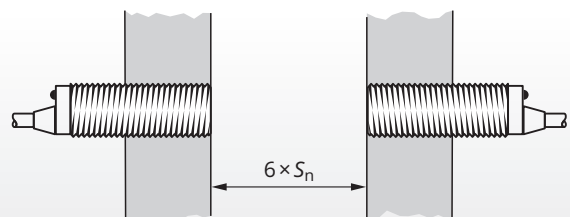

⚠ Caution! This device shall not be used if the safety of persons rely on its faultless function.

XECRO reserves the right to make minor changes without prior notification.