

IA18-N20VI020-G2P

Mind O≠0, I≠I≠1, S≠5, B≠8.

Housing size	M18×1
Mounting	non-flush
Measuring range	0...20 mm
Operating voltage	15...30 V _{DC}
Reverse polarity protection	built-in
Current consumption	<25 mA
Load resistor*	V: ≥10 kΩ · I: ≤500 Ω
Output characteristics	0...10 V · 0...20 mA
Overload protection	built-in
Output frequency	≤300 Hz
Reduction factors	Alu 0.45 · Brs 0.50 · SS 0.85
Operating temperature	0...+70 °C · +33...+159 °F
IP code	IP67
Sensing face material	PBT
Housing material	brass
Connection	PVC, ultra-flex
Clearance z	24 mm
Clearance x	20 mm
Complies with	CE, RoHS



* V: for voltage output · I: for current output



Warranty Our products are manufactured to stringent ISO 9001 European standards to ensure that our customers only receive the best quality.



Inductive Proximity Switch 4-Wire Analog Output Sensing range: *Extended*

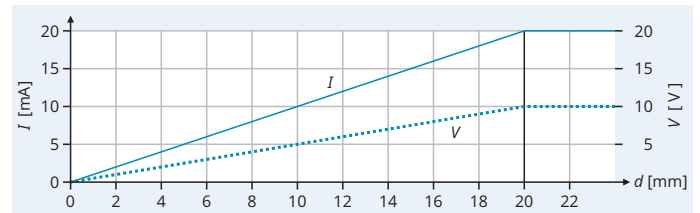
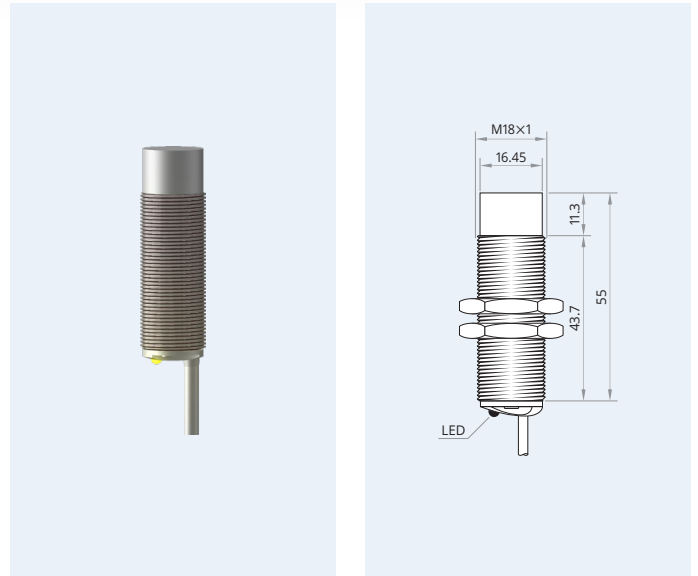

Wiring diagram

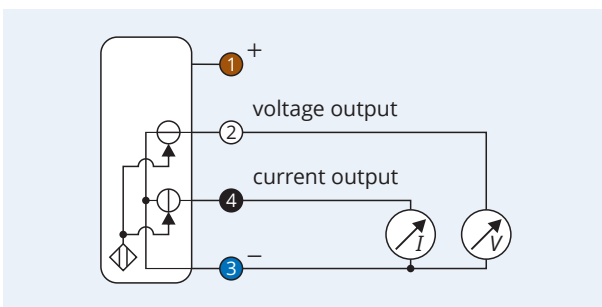

Clearance for parallel mounting

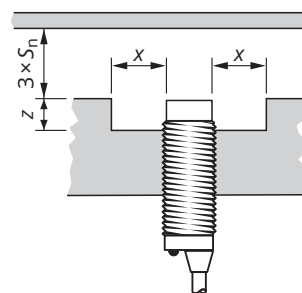

Caution! This device shall not be used if the safety of persons rely on its faultless function.

XECRO reserves the right to make minor changes without prior notification.